

X-TRAY®

AXELENT WIRE TRAY

Mounting instructions X-Tray® for X-Guard



OVERVIEW X-TRAY®

(All in zink plated)

Standard Trays 60

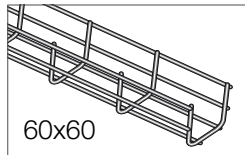

60x60

0101

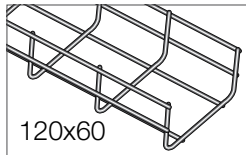

120x60

0111

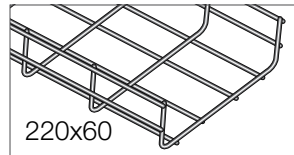

220x60

0121

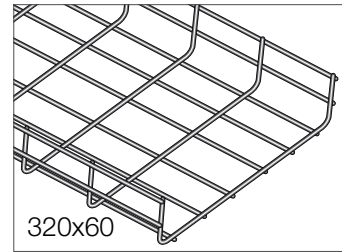

320x60

0131

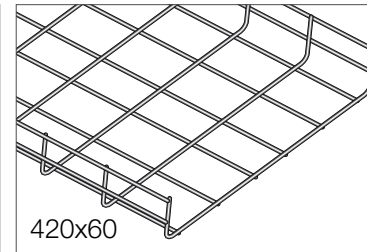

420x60

0141

G-Trays

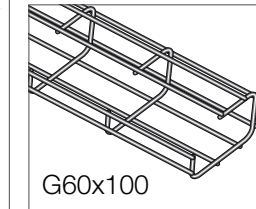

G60x100

1121

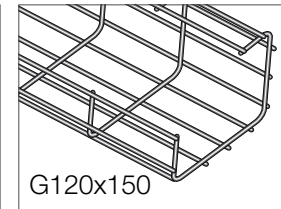

G120x150

1122

Mini Trays

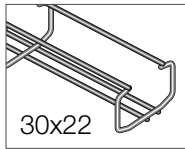

30x22

1152

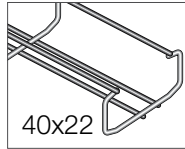

40x22

1153

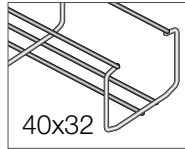

40x32

1154

Fittings

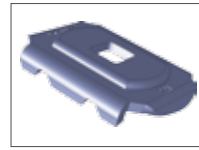

X1 Fitting
2101

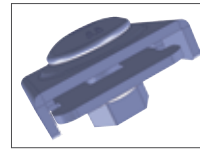

X2 Fitting
2102

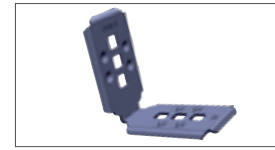

X3 Angled fitting
2103



X4 Fitting
2104

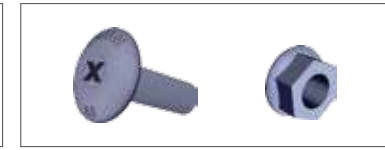

X61 Bolt
2161

X62 Flange nut
2162

Brackets

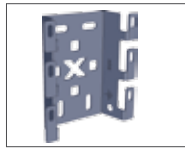

X10 Bracket
2110-1

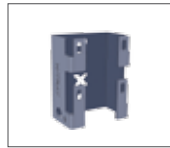

X10 Mini bracket
2110-2

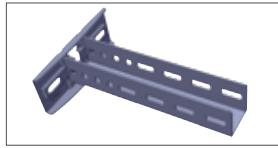

X11 Pendant/T
2111-240

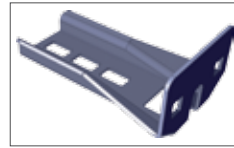

X14 Pendant/L
2114-XXX*

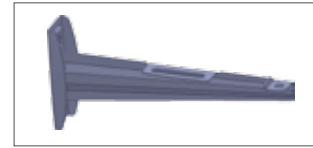

X15 Bracket
2115-XXX*

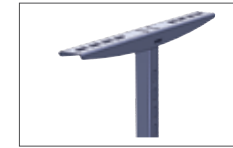

X16 Floor support
2116

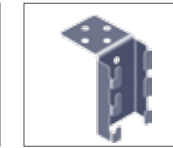

Bracket AX12 90°
7100-015

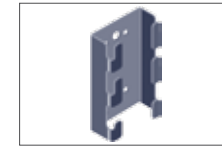

Bracket AX11 with
peps 7100-014



Corner bracket
7100-065

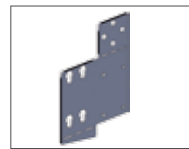

Top corner bracket
7100-066

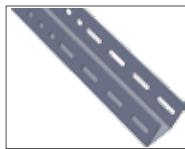

U-profile
01-2112-240

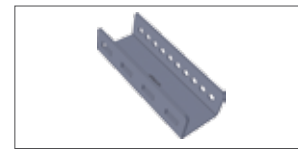

Bracket holder aluminium
rail 7100-037



Adjustable post holder
7100-060

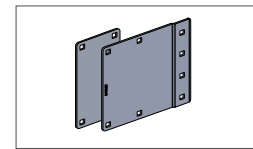

Adjustable post holder
for corner 7100-072



Bracket holder door
7100-067 / 7100-068

Tools

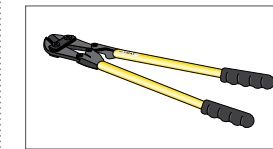

X75 Bolt cutter
2575



X76 Spanner 13 mm
2576

Tillbehör

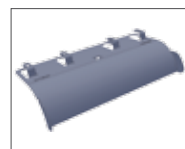

X60 Radius
limiter
2160-XXX*

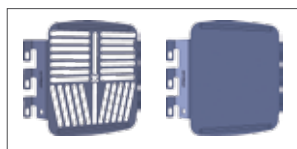

X63 Accessories holder
2163-1 / 2163-2

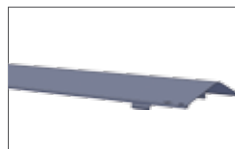

X65 X-Tray cover
2265-XXX*

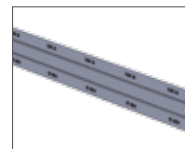

X66 X-Tray
divider 45 mm
2266-45



X67 X-Tray
divider clamp
2267



X68 Earth
connection clamp
2568

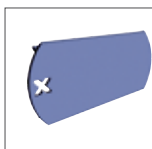

X70 Marking
clip
2570-0X

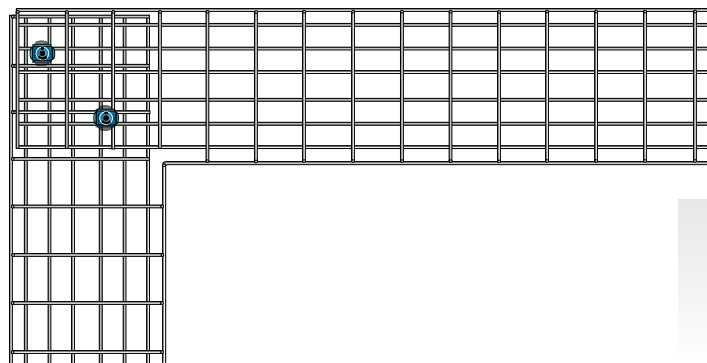
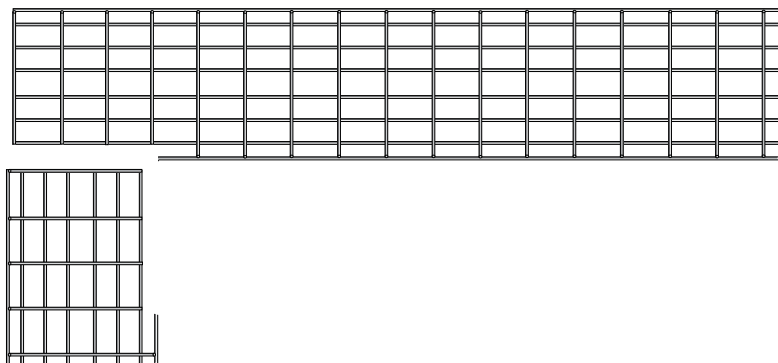

X72 Safety cap
2572-X

A

X1 x4 **X62** x2 **X61** x2 **X72**

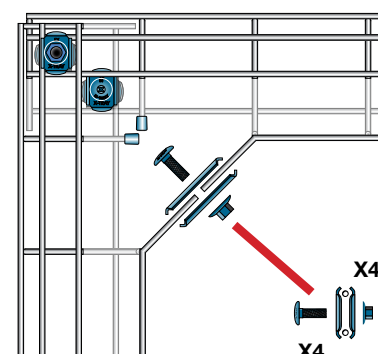
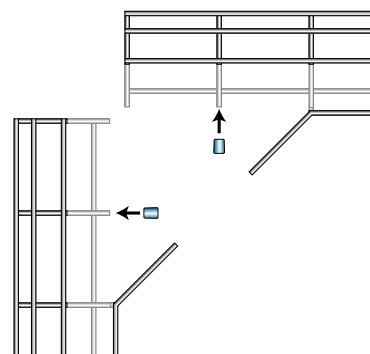
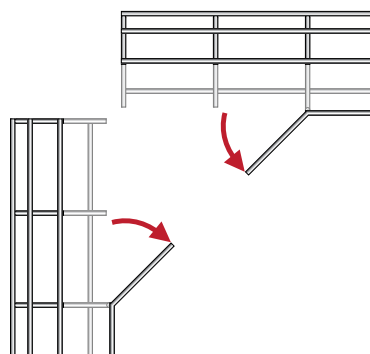
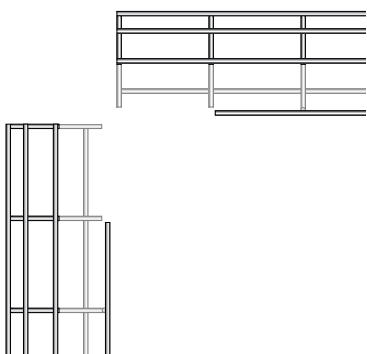
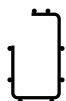
B

X1 x4 **X4** x2 **X62** x3 **X61** x3 **X72** x2

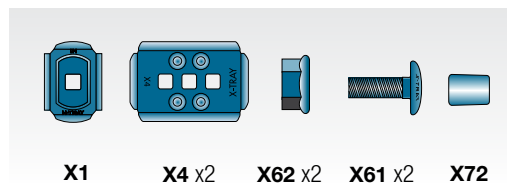
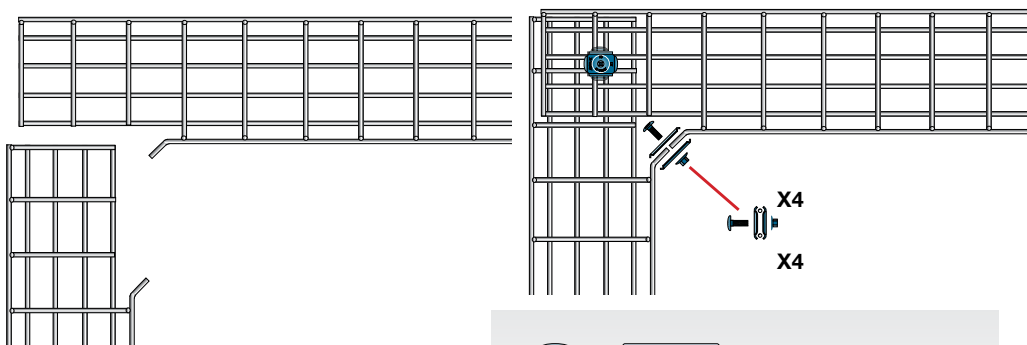
C

X1 **X4** x2 **X62** x2 **X61** x2 **X72**

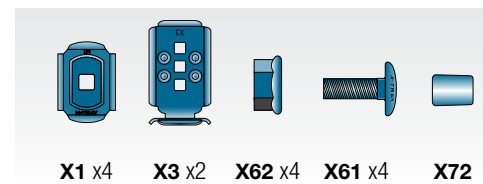
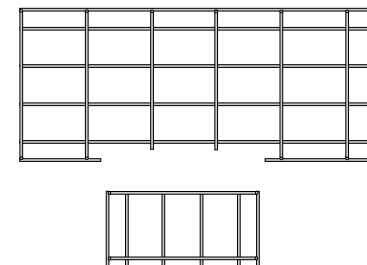
D

X1 x4 **X3** x2 **X62** x4 **X61** x4 **X72**

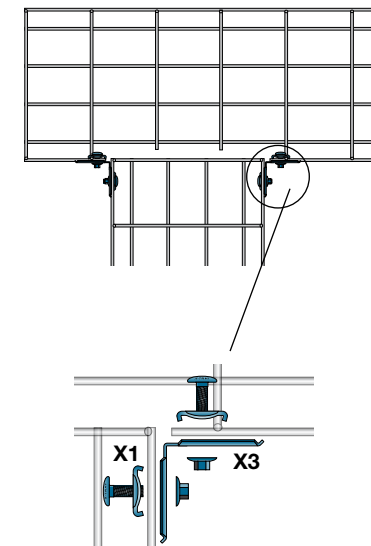

* For more info about cutting the wire tray, see our technical manual.

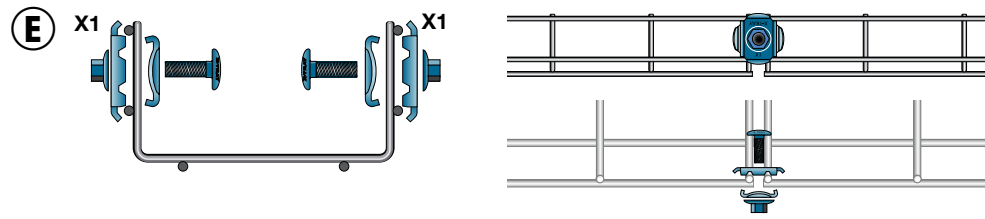

- X1 x4
- X62 x2
- X61 x2

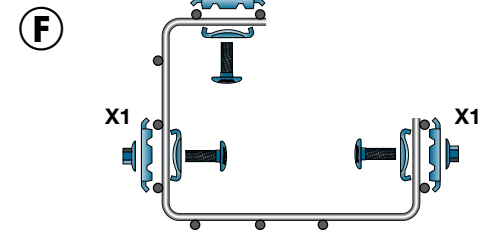

- X1 x6
- X62 x3
- X61 x3

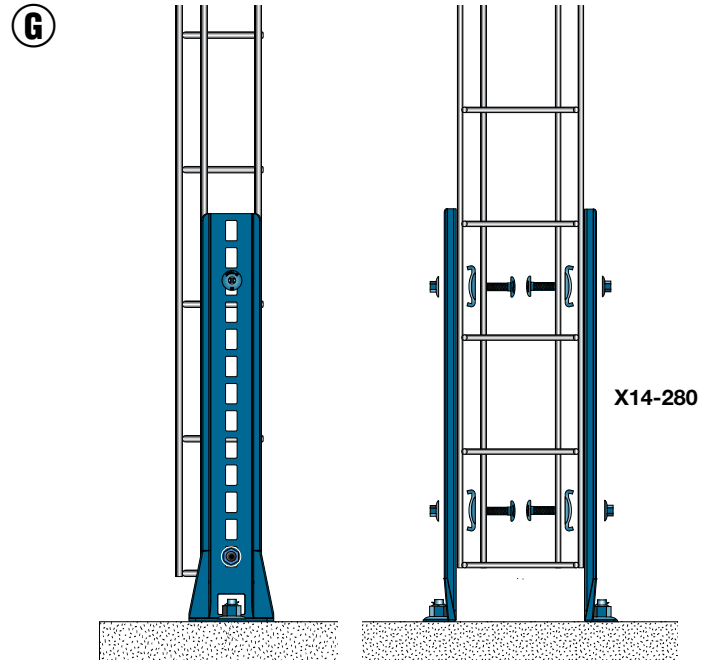

- X14-280
- X1 x4
- X62 x4
- X61 x4
- 7100-031 x2
- X14-280 x2

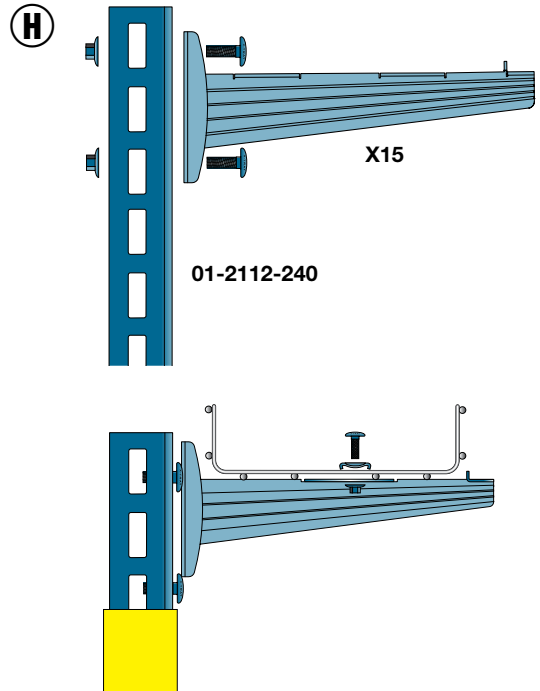

- 01-2112-240
- X15
- X1 x1
- X62 x3
- X61 x3
- X15 x1
- 01-2112-240 x1

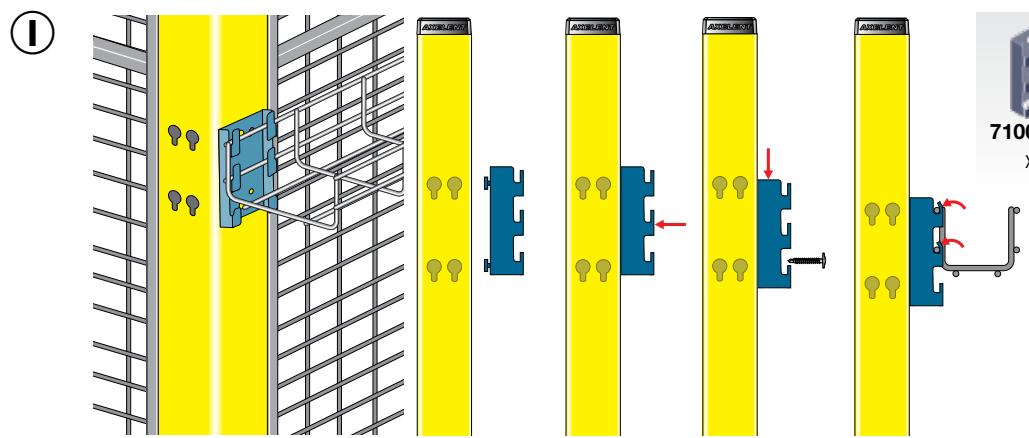

- 7100-014 x1

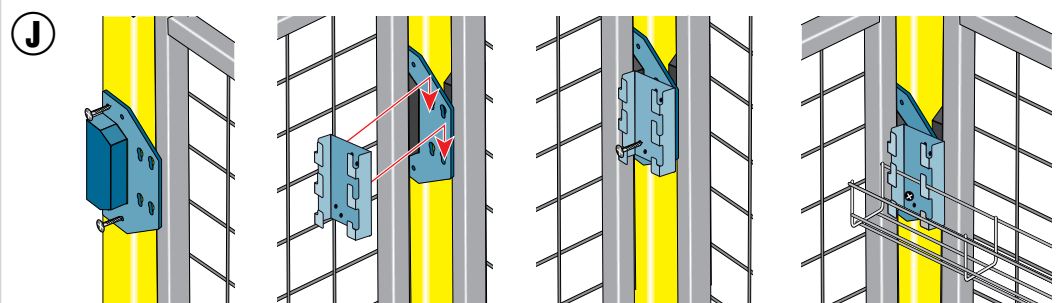

- x2
- 7100-065 x1
- x1
- 7100-014 x1

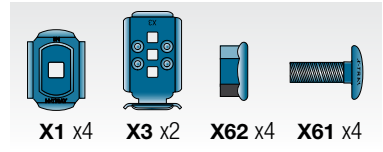
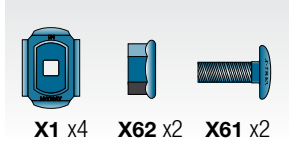
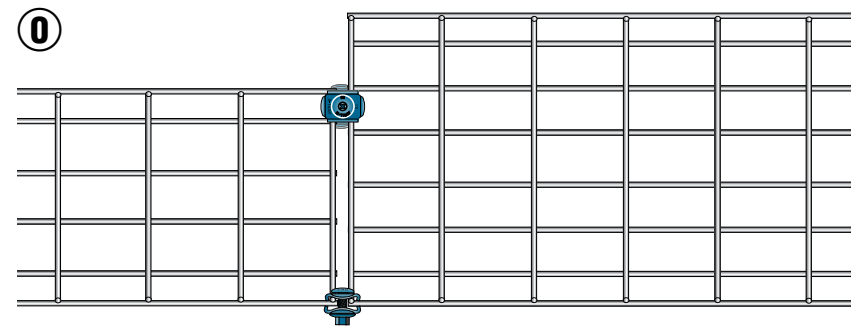
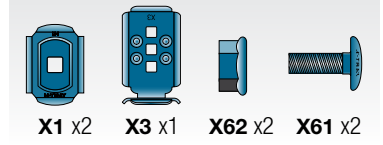
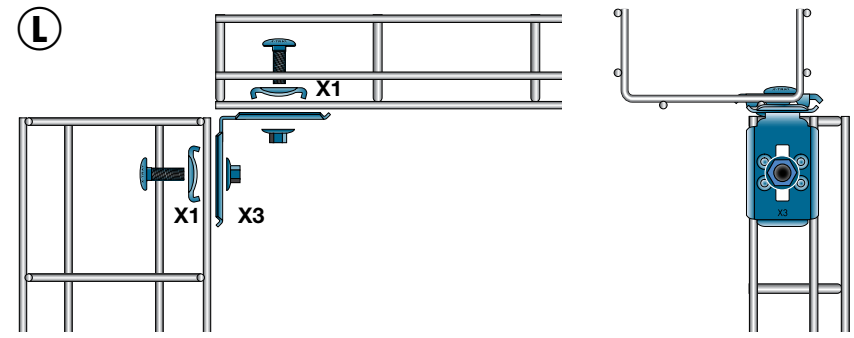
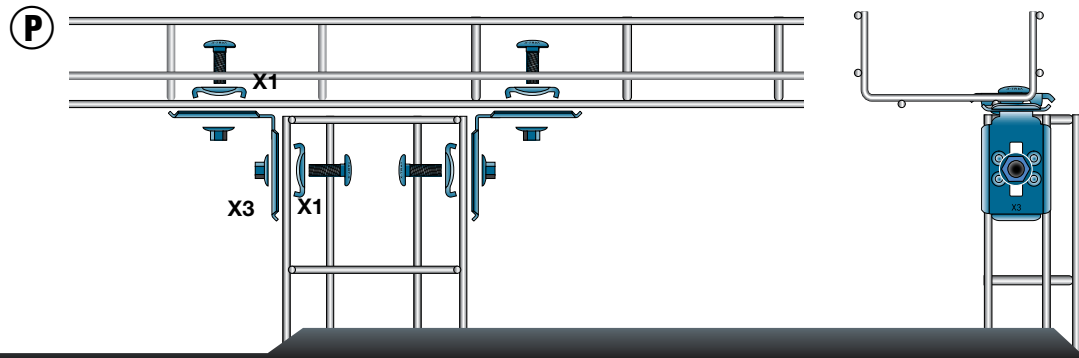
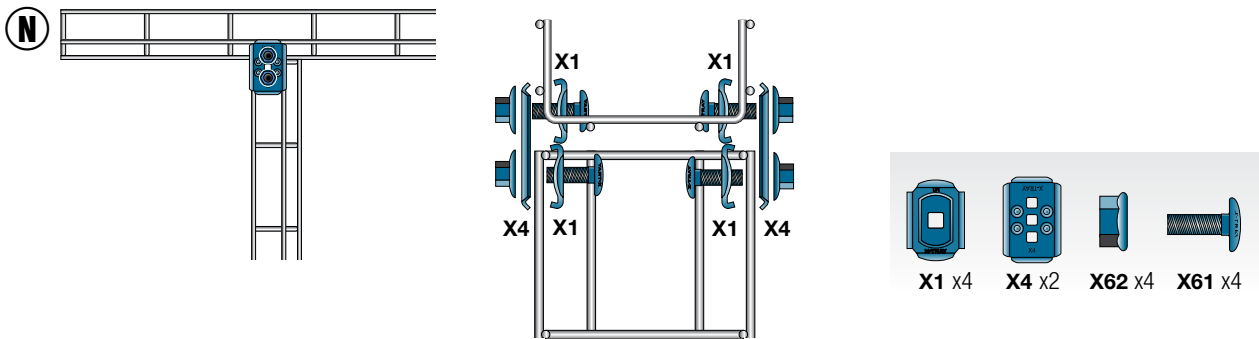
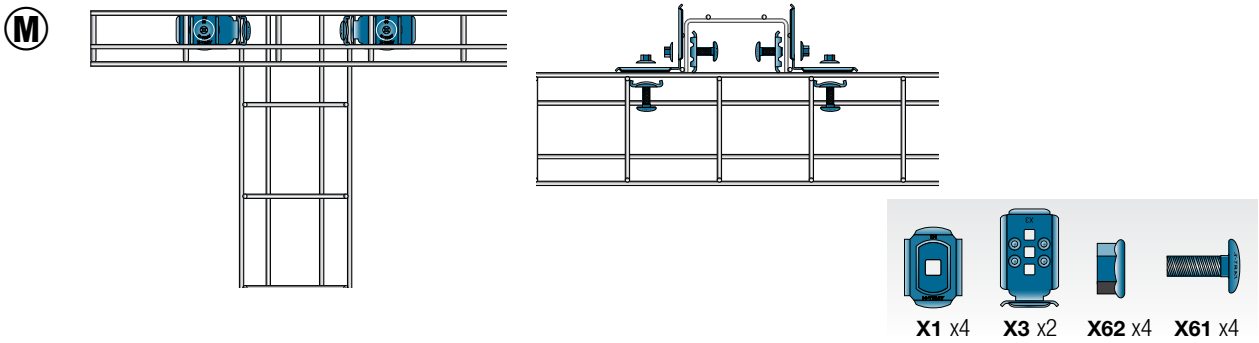
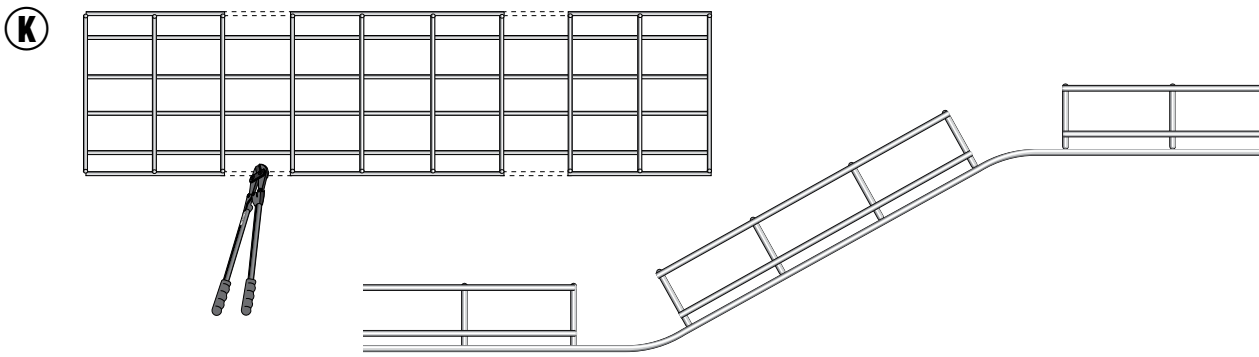

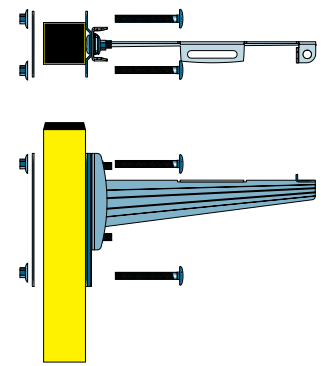
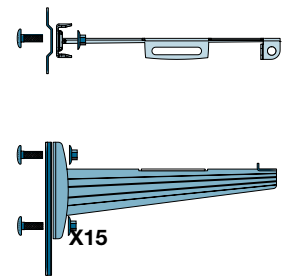
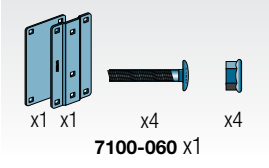
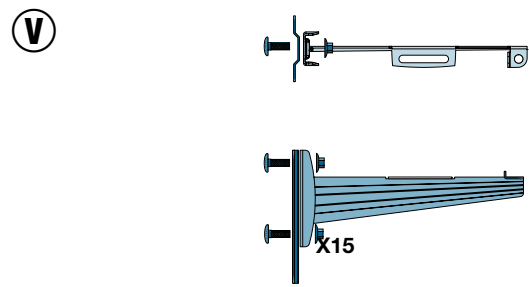
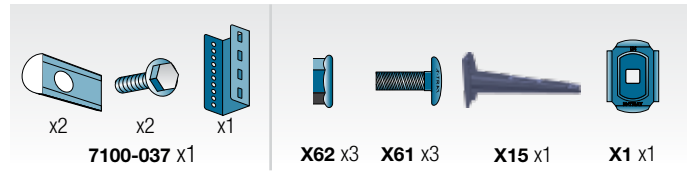
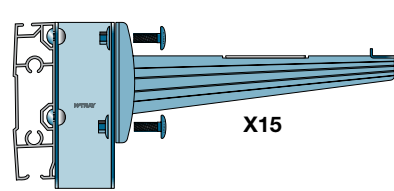
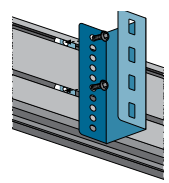
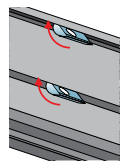
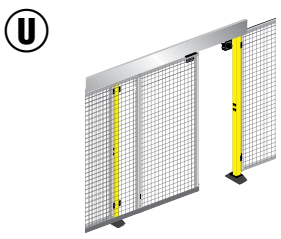
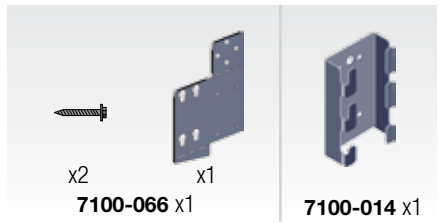
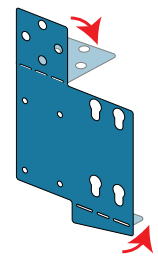
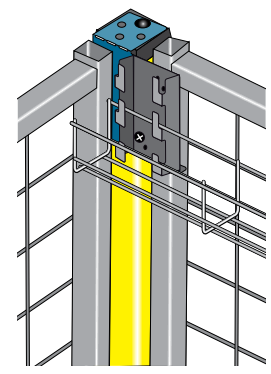
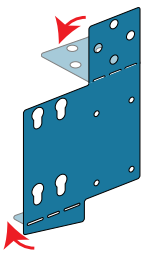
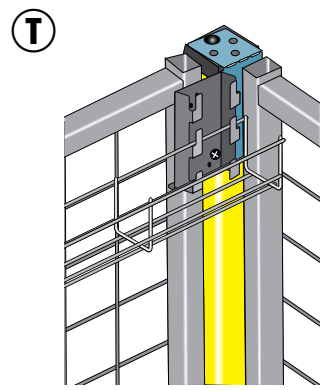
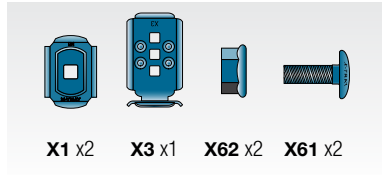
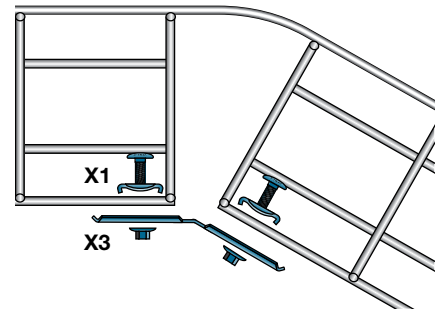
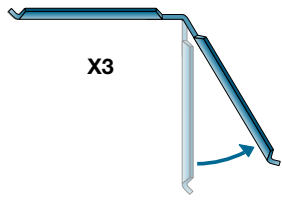
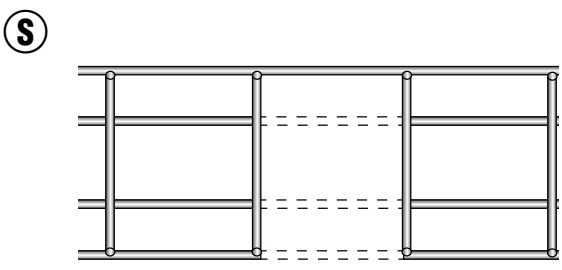
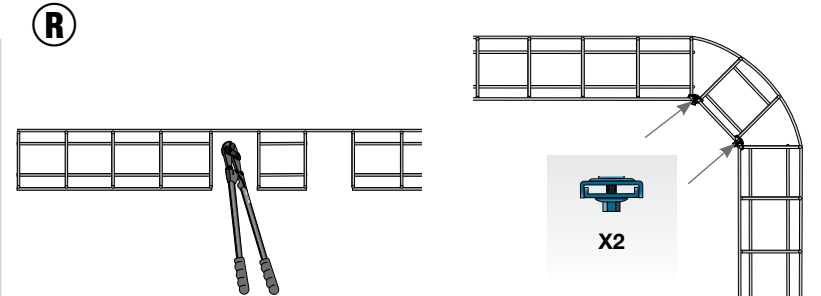
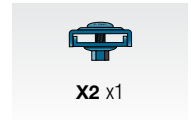
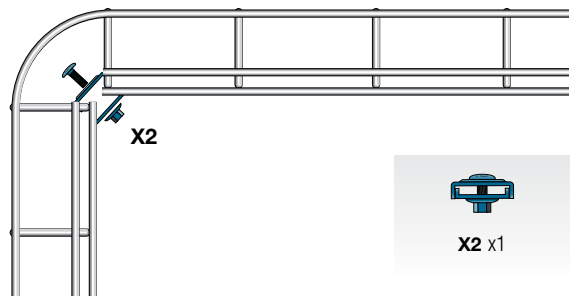
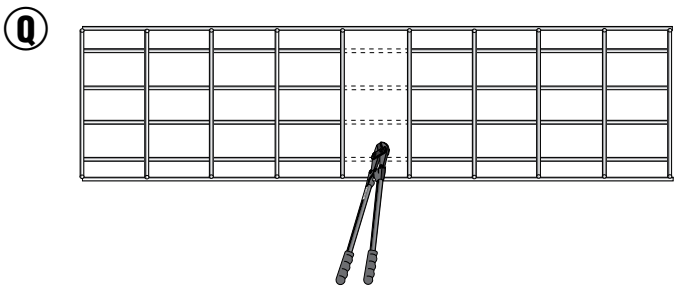

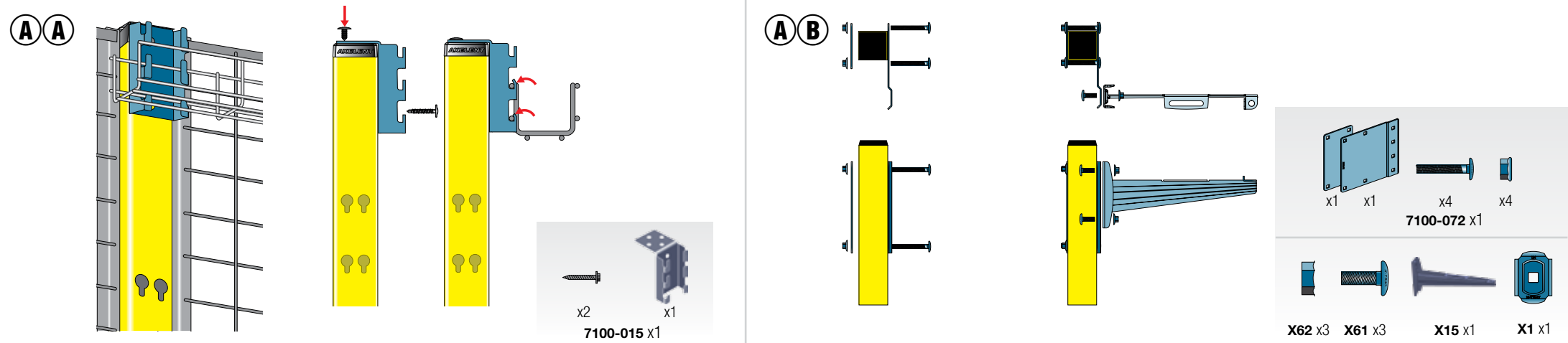
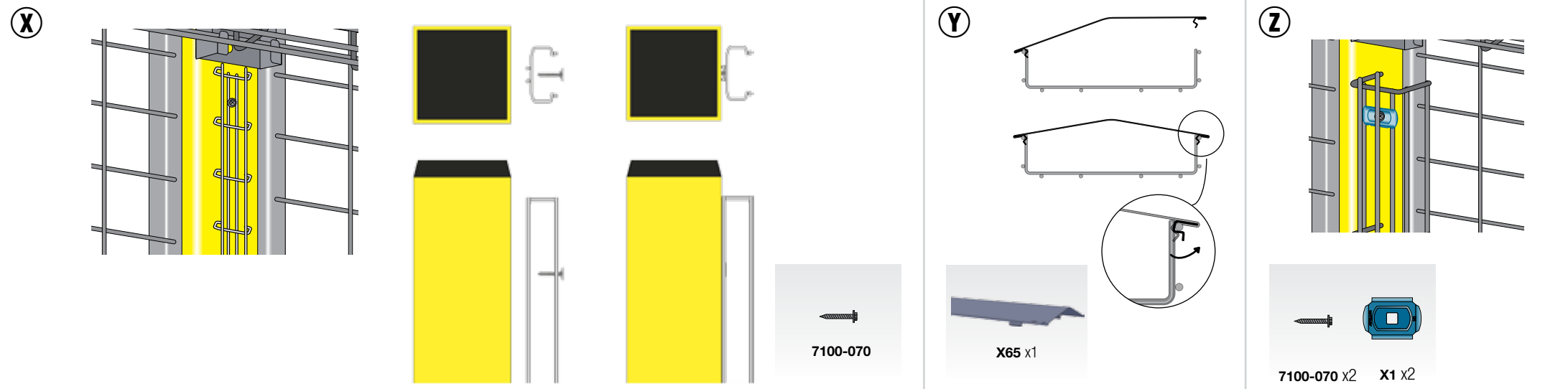
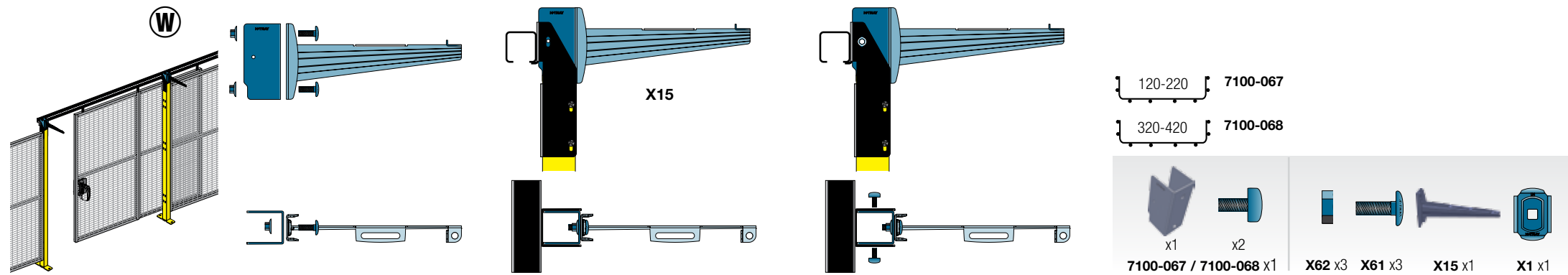

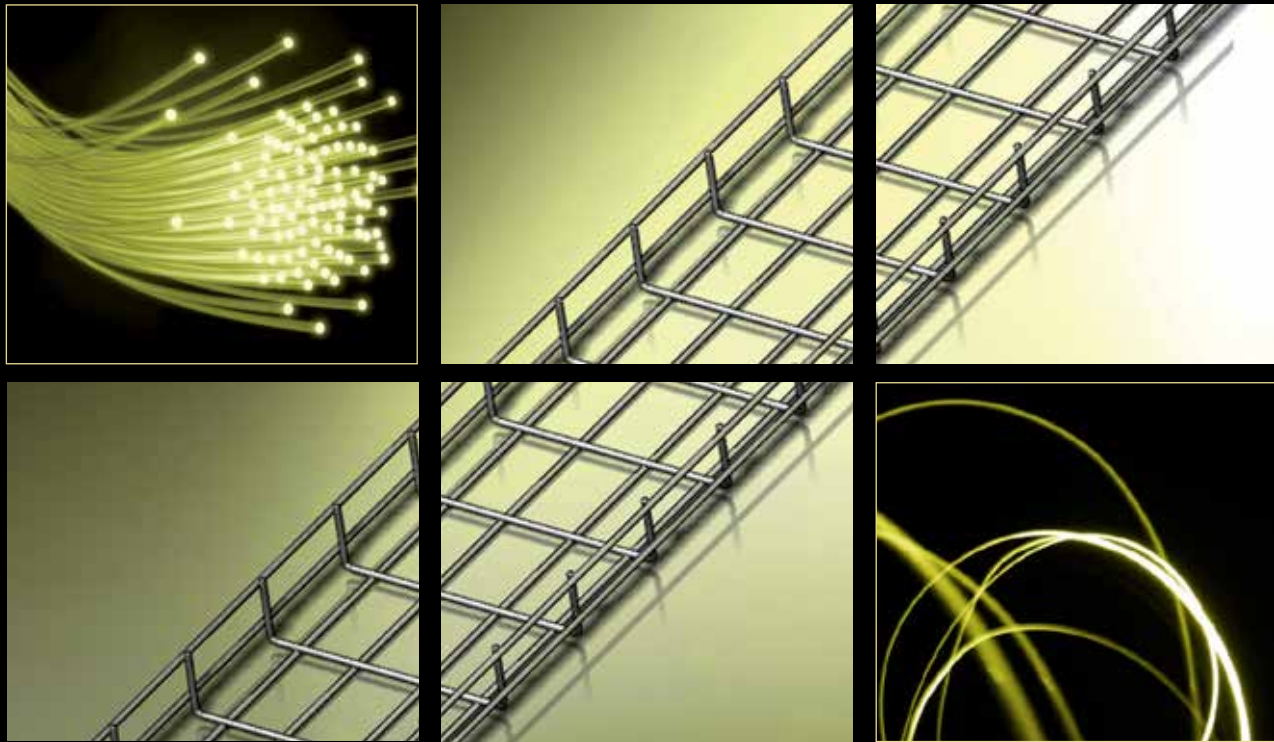

AXELENT WIRE TRAY AB

Axelent AB is a leading and rapidly growing company that produces and sells mesh panel systems for machine guarding and partitioning within industry, warehousing and property protection. Axelent AB also embraces business area Axelent Safety, which offers complete machine safety solutions. The Axelent Group also includes Axelent Wire Tray AB (cable trays), Axelent Software (software) and Axelent Engineering AB (automation solutions). Axelent's head office is in Hillerstorp, Sweden, along with product development, production, storage and packaging. Axelent has sales offices in over 50 countries and the products are sold worldwide.



AXELENT WIRE TRAY AB

Box 1 · Kävsjövägen 17

SE-330 33 Hillerstorp

Direct: +46 (0)370 37 32 58

Tel: +46 (0)370 37 37 30

E-mail: sales@axelentwt.com

Internet: www.axelentwt.se